

Lumana LT800

Turret Camera

8MP, Indoor/Outdoor



8MP image sensor delivers sharp 4K, 3840 x 2160 video resolution

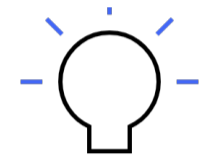

30m / 98ft infrared illuminators for greater nighttime visibility

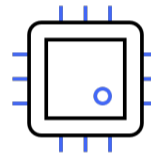

Real-time AI processing and minimal bandwidth impact (~100 Kbps)



Ready for any environment with IP67 weatherproof and IK10 vandal-resistance

Lumana open, hybrid-cloud architecture

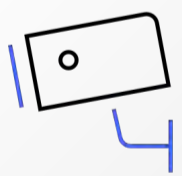

Any IP camera

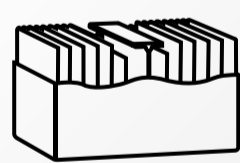

Lumana Core



Lumana Cloud

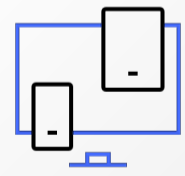

Remote access

Camera agnostic

Open platform provides powerful AI analytics to any security camera for greater situational awareness and operational efficiency.

Actionable intelligence

Generative AI adapts to your environment, predicts anomalies, and triggers automatic alerts and responses for proactive security management.

Infinitely scalable

Easily manage unlimited cameras, locations, and users from one platform and utilize AI to empower your team to do more with fewer resources.

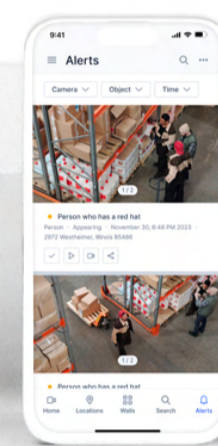
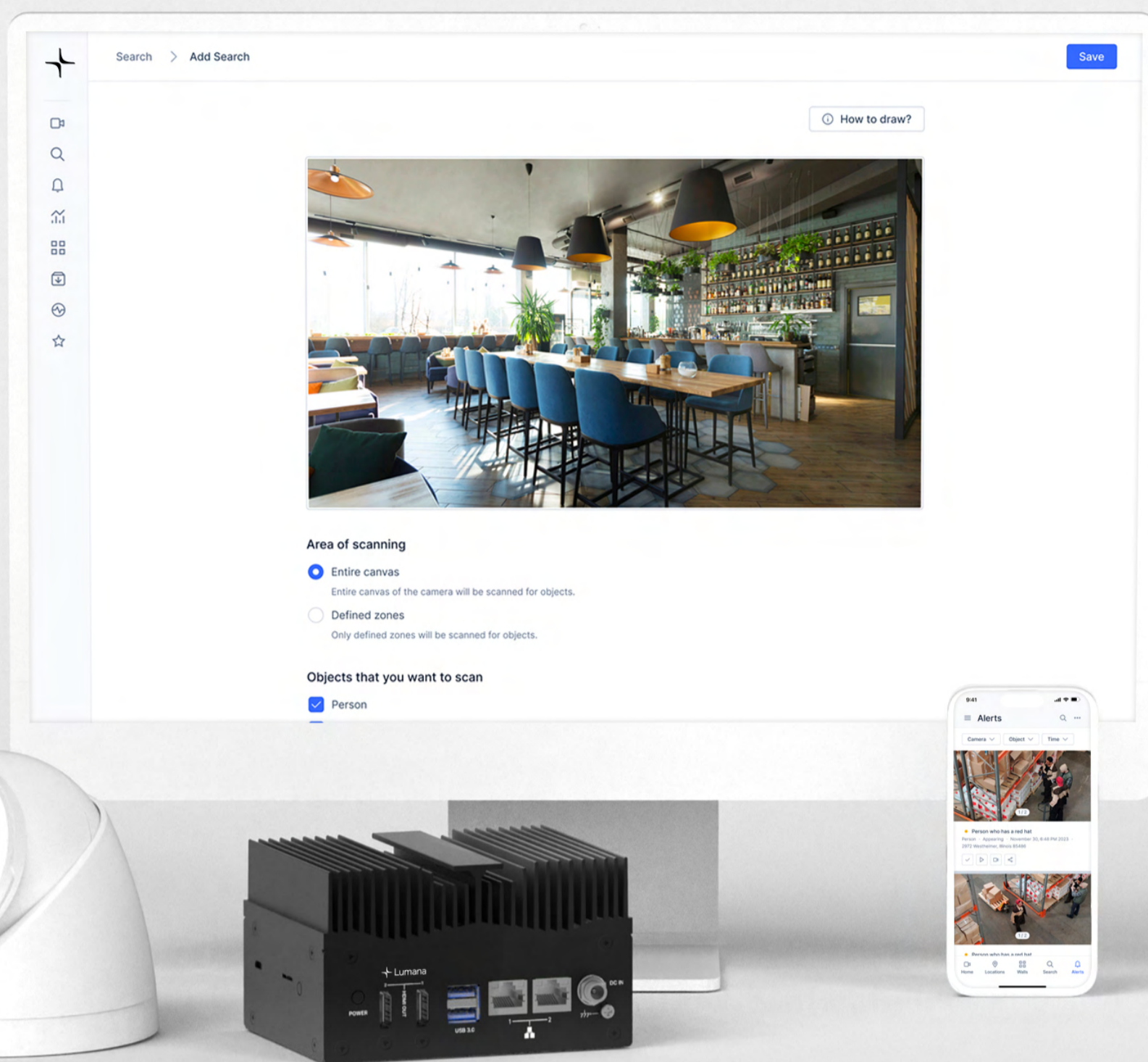

Modern system management

Designed for easy deployment and enhanced reliability, Lumana delivers the best from on-premise and cloud solutions for a modern and refined security experience.

- Centralized management and secure remote access
- Plug-and-play setup — integrate visual AI in minutes
- Automatic updates and system health monitoring

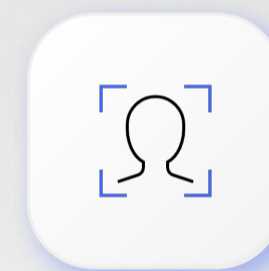

Next-generation AI features

Patented AI and machine learning algorithms empower your team to operate more efficiently by delivering unparalleled visibility and new business insights at scale.

- Receive real-time alerts for immediate response
- Find people or vehicles of interest in seconds
- New AI features and system upgrades at no cost

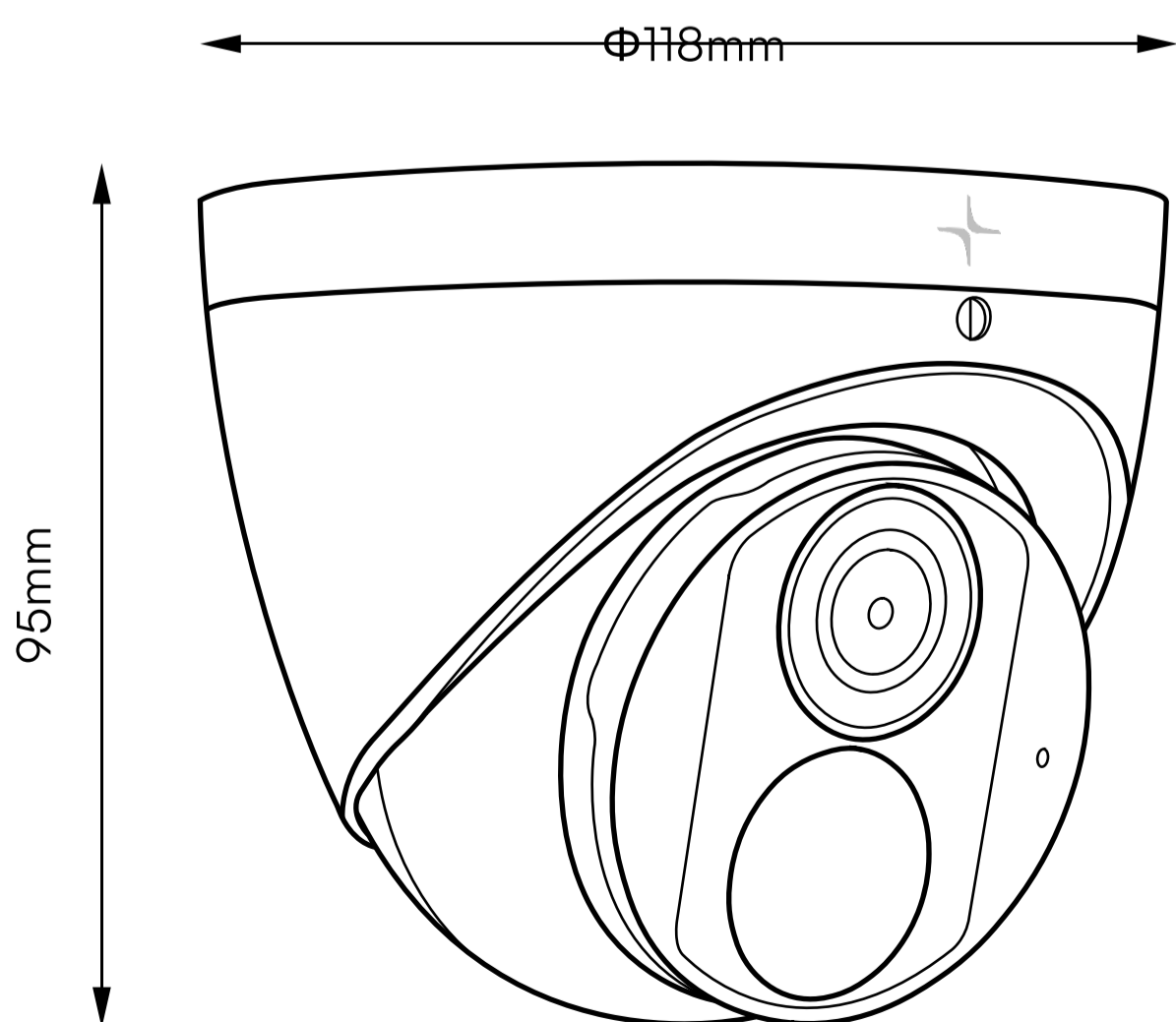

Dimensions

Φ118 x 95mm (Ø4.6" x 3.8")

Weight

0.36kg (0.79lb)

Body

Metal + Plastic

Warranty

Lifetime*

Operating temperature

-30°C ~ 60°C (-22°F ~ 140°F)

Humidity

≤95% RH (non-condensing)

Ingress protection

IP67

Vandal resistance

IK10

Certifications

NDA, FCC Part 15, EN 60950-1, UL60950-1, IEC 60950-1

Camera Features

Image sensor	1/2.7", 8.0 megapixel, progressive scan, CMOS	Field of view	H: 112.9° V: 59.1° D: 121.2°
Sensor resolution	3840 x 2160px	Sensor movement	Pan: 0° ~ 360° Tilt: 0° ~ 80° Rotate: 0° ~ 360°
Lens type	Fixed-focal	Shutter speed	1 ~ 1/1000000s
Focal length	2.8mm	Day/Night	IR-cut filter with auto switch (ICR)
Aperture	F1.6	IR range	Up to 30m (98ft)
Iris	N/A	WDR	120dB

Standard Video Settings

Compression	Ultra 265, H.265, H.264, MJPEG	Historical video settings	Dynamic Storage**
Frame rate	Max 30fps / Min 20fps	White balance	Auto/Outdoor/Fine Tune/Sodium Lamp/Locked/Auto2
Bitrate	128 Kbps~16 Mbps	Digital noise reduction	2D/3D DNR
9:16 corridor mode	Supported	Flip	Normal/Vertical/ Horizontal/180°/90°Clockwise/90° Anti-clockwise

Standard Audio Settings

Audio	Supported	Interface	Built in microphone
--------------	-----------	------------------	---------------------

Power and Network

Power input	DC 12V±25%, PoE (IEEE 802.3af)	Protocols	IPv4, IGMP, ICMP, ARP, TCP, UDP, DHCP, RTP, RTSP, RTCP, RTMP, DNS, DDNS, NTP, FTP, UPnP, HTTP, HTTPS, SMTP, SSL/TLS, 802.1x, SNMP
Power consumption	Max 4.5W	Compatible integration	ONVIF (Profile S, Profile G, Profile T), API
Connectivity	1 x RJ45 10M/100M Base-TX Ethernet 1 x Ø 5.5mm coaxial power plug (optional, in case PoE isn't supported)		

*Must remain a customer to qualify for lifetime warranty

**All Lumana cameras store footage dynamically on the Lumana Core based on activity. A combination of standard-quality and high-quality images and videos is captured to ensure optimal footage during critical events.